

Cat. # 6230, 6650 - 6657,
6668, 6669, 6673

For Research Use

TAKARA

AAVpro[®] Helper Free System

Product Manual

【 For China/Korea/India/Europe 】

Table of Contents

I.	Description.....	4
II.	Components	7
III.	Storage	13
IV.	Materials Required but not Provided	13
V.	Overview of AAV Particle Preparation.....	14
VI.	Protocol.....	14
VII.	Measurement of Virus Titer	17
VIII.	Reference Data	18
IX.	References.....	22
X.	Related Products	22

Safety & Handling of Adeno-Associated Virus Vectors

The protocols in this user manual require the handling of adeno-associated virus vectors. It is imperative to fully understand the potential hazards of and necessary precautions for laboratory use of these vectors.

Viruses produced with AAV-based vectors could, depending on your gene insert, be potentially hazardous. Similar vectors have been approved for human gene therapy trials, attesting to their potential ability to express genes *in vivo*. For these reasons, due caution must be exercised in the production and handling of any recombinant viruses.

Follow all applicable guidelines for research involving recombinant DNA. Take appropriate safety measures when producing or handling recombinant adeno-associated viruses, including working in a biological safety cabinet and wearing protective laboratory coats, face protection, and gloves.

Available AAVpro Products

pAAV-ZsGreen1 Vector	Cat. #6231
AAVpro® Purification Kit (All Serotypes)	Cat. #6666
AAVpro® Purification Kit (AAV2)	Cat. #6232
AAVpro® Titration Kit (for Real Time PCR) Ver.2	Cat. #6233
AAVpro® Extraction Solution	Cat. #6235
AAVpro® Packaging Plasmid (AAV1)	Cat. #6672
AAVpro® Packaging Plasmid (AAV2)	Cat. #6234
AAVpro® Packaging Plasmid (AAV5)	Cat. #6664
AAVpro® Packaging Plasmid (AAV6)	Cat. #6665
AAVpro® 293T Cell Line	Cat. #632273

I. Description

I-1. Adeno-Associated Virus

Adeno-Associated Virus (AAV) is a non-enveloped virus that belongs to the *Parvovirus* family of the *Dependovirus* genus. AAV is not thought to be pathogenic to humans and only replicates in the presence of a helper virus, such as adenovirus or herpesvirus. The AAV genome is a linear, single-strand DNA molecule of approximately 4.7 kb that has terminal hairpin structures called inverted terminal repeats (ITRs) at both ends. ITRs function as origins of genomic replication and contribute to packaging of viral particles. The AAV genome includes three open reading frames (Figure 1): Rep, which encodes a protein involved in replication and transcription; Cap, which encodes capsid proteins; and AAP, which encodes a non-structural protein necessary for formation of viral particles. The Rep region codes for 4 different proteins (Rep78, Rep68, Rep52, and Rep40), and the Cap region codes for 3 different proteins (VP1, VP2, and VP3).

There are more than 100 serotypes of AAV, and the host specificity and characteristics of the virus differ among serotypes. TaKaRa Bio Inc. provides kits for preparation of AAV serotype 1 (AAV1), serotype 2 (AAV2), serotype 5 (AAV5), and serotype 6 (AAV6). AAV serotype 2 (AAV2) is the most commonly used serotype in AAV-based research, including gene therapy, and is characterized by a broad host range. The tissue host range of AAV1, AAV5, and AAV6 are highly limited. AAV1 has high transduction efficiency for muscle, liver, respiratory tract, and central nervous system. AAV5 has high transduction efficiency for central nervous system, liver, and retina. AAV6 has high transduction efficiency for cardiomyocyte, muscle, and liver.

Adeno-associated virus vectors (AAV vectors) exploit the properties of AAV for transduction of genes to cells and organisms. AAV vectors are used as research tools and also as vectors for gene therapy. In addition, AAV vectors are generally considered safer than adenoviral and retroviral vectors. AAV vectors can be used to transduce genes into both proliferating and non-proliferating cells and can impart long-term expression in non-dividing cells. In addition, AAV has little immunogenicity and is suitable for the transduction of genes into animals (as an *in vivo* transduction tool).

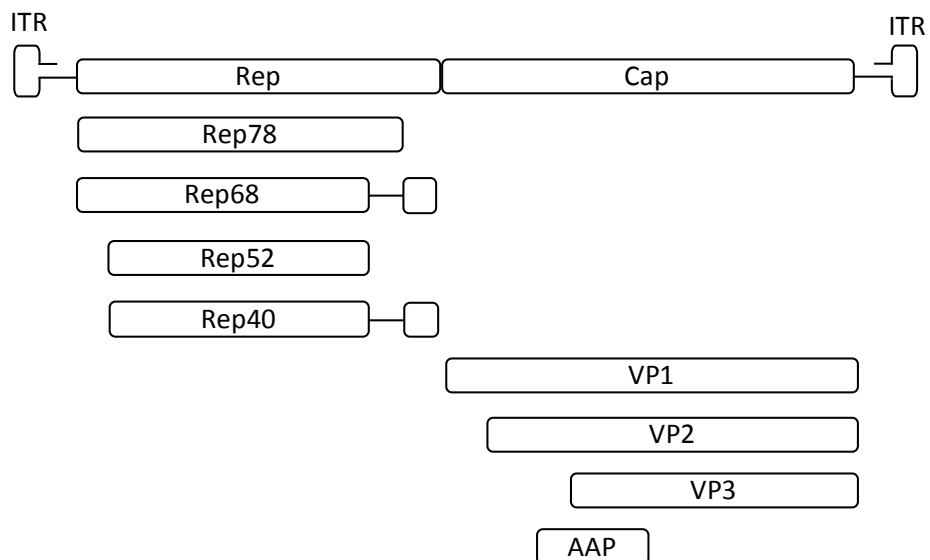

Figure 1. AAV genome structure and open reading frames.

I-2. Principles

Each AAVpro Helper Free System enables the preparation of AAV particles of serotype 1, 2, 5, or 6 without the use of a helper virus. The AAV particles produced can be used to obtain transient expression of the target gene in mammalian cells or individual animals.

For *in vivo* applications, purification of AAV vector with the AAVpro Purification Kit (All Serotypes) (Cat. #6666) is recommended. For AAV2, AAVpro Purification Kit (AAV2) (Cat. #6232) is also available.

I-3. Features

A. Preparation of AAV Vector with the AAV Helper-Free System

The AAV Helper Free Systems are unique systems for the preparation of high-titer AAV particles without the use of a helper virus (Figure 2). Each kit includes three plasmids encoding the factors necessary to prepare recombinant AAV particles by transfection into HEK293 cells.

- pAAV Vector: Plasmid containing a promoter for gene expression and two ITRs
 - pAAV-CMV Vector (Cat. #6673, 6230, 6650, 6651)
Plasmid contains a site for cloning a gene of interest (GOI). The GOI is expressed from a CMV promoter. The size of the GOI cloned into the pAAV-CMV vector should be <2.5 kb as there is a limit to the size of DNA that can be encapsulated in AAV particles.
 - pAAV-CRE Recombinase Vector (Cat. #6668, 6652, 6653, 6654)
This vector is used to prepare AAV particles that will deliver the loxP-dependent Cre recombinase gene. Cre recombinase has been widely used for generating transgenic mice and for various screening assays.
 - pAAV-LacZ Vector (Cat. #6669, 6655, 6656, 6657)
This vector is used to prepare AAV particles that will deliver a LacZ expression cassette. AAV-LacZ particles can be used as a control for *in vitro* and *in vivo* gene transfer.
 - pRC Vector: Plasmid that expresses the Rep gene of AAV2 and the Cap gene of each serotype below.
 - pRC1 Vector: Serotype 1 (Cat. #6673, 6668, 6669)
 - pRC2-mi342 Vector*: Serotype 2 (Cat. #6230, 6652, 6655)
 - pRC5 Vector: Serotype 5 (Cat. #6650, 6653, 6656)
 - pRC6 Vector: Serotype 6 (Cat. #6651, 6654, 6657)
 - pHelper Vector: Plasmid that expresses adenovirus E2A, E4, and VA
- * pRC2-mi342 expresses hsa-miR-342, a human microRNA that increases AAV2 titer in vector preparation systems. It increases titer by approximately 2-fold as compared to ordinary pRC2 vectors that express only Rep and Cap (VIII. Reference Data).

B. AAV Particle Extraction using AAV Extraction Solution

Extraction of AAV particles from AAV-producing cells is conventionally performed by freeze-thaw or sonication methods; however, these methods are time consuming and require special equipment. This kit includes AAV Extraction Solutions that allow simple and efficient AAV particle isolation while minimizing protein and nucleic acid contamination.

The AAVpro Extraction Solution (Cat. #6235), which contains AAVpro Extraction Solutions A and B, can be purchased separately.

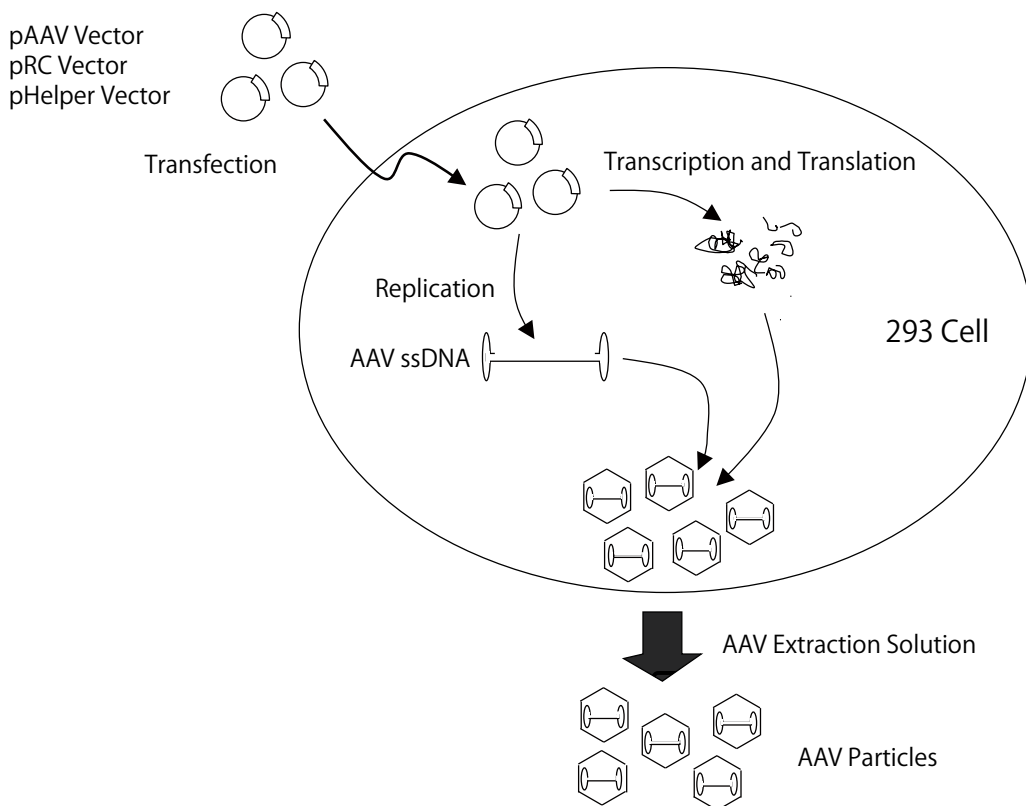

Figure 2. Preparation of AAV particles using the AAVpro Helper Free System.

II. Components

Each kit includes three plasmids encoding the factors necessary to prepare recombinant AAV particles, and reagents for extracting AAV particles from producer cells.

[Serotype 1]

AAVpro Helper Free System (AAV1) (Cat. #6673)

- | | |
|---|-----------------------|
| 1. pAAV-CMV Vector (1 $\mu\text{g}/\mu\text{l}$) | 20 μl |
| 2. pRC1 Vector (1 $\mu\text{g}/\mu\text{l}$) | 20 μl |
| 3. pHelper Vector (1 $\mu\text{g}/\mu\text{l}$) | 20 μl |
| 4. AAV Extraction Solution A | 1.5 ml x 3 |
| 5. AAV Extraction Solution B | 150 μl x 3 |

AAVpro Helper Free System (AAV1-CRE Recombinase) (Cat. #6668)

- | | |
|---|-----------------------|
| 1. pAAV-CRE Recombinase Vector (1 $\mu\text{g}/\mu\text{l}$) | 20 μl |
| 2. pRC1 Vector (1 $\mu\text{g}/\mu\text{l}$) | 20 μl |
| 3. pHelper Vector (1 $\mu\text{g}/\mu\text{l}$) | 20 μl |
| 4. AAV Extraction Solution A | 1.5 ml x 3 |
| 5. AAV Extraction Solution B | 150 μl x 3 |

AAVpro Helper Free System (AAV1-LacZ) (Cat. #6669)

- | | |
|--|-----------------------|
| 1. pAAV-LacZ Vector (1 $\mu\text{g}/\mu\text{l}$) | 20 μl |
| 2. pRC1 Vector (1 $\mu\text{g}/\mu\text{l}$) | 20 μl |
| 3. pHelper Vector (1 $\mu\text{g}/\mu\text{l}$) | 20 μl |
| 4. AAV Extraction Solution A | 1.5 ml x 3 |
| 5. AAV Extraction Solution B | 150 μl x 3 |

[Serotype 2]

AAVpro Helper Free System (AAV2) (Cat. #6230)

- | | |
|---|-----------------------|
| 1. pAAV-CMV Vector (1 $\mu\text{g}/\mu\text{l}$) | 20 μl |
| 2. pRC2-mi342 Vector (1 $\mu\text{g}/\mu\text{l}$) | 20 μl |
| 3. pHelper Vector (1 $\mu\text{g}/\mu\text{l}$) | 20 μl |
| 4. AAV Extraction Solution A | 1.5 ml x 3 |
| 5. AAV Extraction Solution B | 150 μl x 3 |

AAVpro Helper Free System (AAV2-CRE Recombinase) (Cat. #6652)

- | | |
|---|-----------------------|
| 1. pAAV-CRE Recombinase Vector (1 $\mu\text{g}/\mu\text{l}$) | 20 μl |
| 2. pRC2-mi342 Vector (1 $\mu\text{g}/\mu\text{l}$) | 20 μl |
| 3. pHelper Vector (1 $\mu\text{g}/\mu\text{l}$) | 20 μl |
| 4. AAV Extraction Solution A | 1.5 ml x 3 |
| 5. AAV Extraction Solution B | 150 μl x 3 |

AAVpro Helper Free System (AAV2-LacZ) (Cat. #6655)

- | | |
|---|-----------------------|
| 1. pAAV-LacZ Vector (1 $\mu\text{g}/\mu\text{l}$) | 20 μl |
| 2. pRC2-mi342 Vector (1 $\mu\text{g}/\mu\text{l}$) | 20 μl |
| 3. pHelper Vector (1 $\mu\text{g}/\mu\text{l}$) | 20 μl |
| 4. AAV Extraction Solution A | 1.5 ml x 3 |
| 5. AAV Extraction Solution B | 150 μl x 3 |

[Serotype 5]

AAVpro Helper Free System (AAV5) (Cat. #6650)

1. pAAV-CMV Vector (1 $\mu\text{g}/\mu\text{l}$) 20 μl
2. pRC5 Vector (1 $\mu\text{g}/\mu\text{l}$) 20 μl
3. pHelper Vector (1 $\mu\text{g}/\mu\text{l}$) 20 μl
4. AAV Extraction Solution A 1.5 ml x 3
5. AAV Extraction Solution B 150 μl x 3

AAVpro Helper Free System (AAV5-CRE Recombinase) (Cat. #6653)

1. pAAV-CRE Recombinase Vector (1 $\mu\text{g}/\mu\text{l}$) 20 μl
2. pRC5 Vector (1 $\mu\text{g}/\mu\text{l}$) 20 μl
3. pHelper Vector (1 $\mu\text{g}/\mu\text{l}$) 20 μl
4. AAV Extraction Solution A 1.5 ml x 3
5. AAV Extraction Solution B 150 μl x 3

AAVpro Helper Free System (AAV5-LacZ) (Cat. #6656)

1. pAAV-LacZ Vector (1 $\mu\text{g}/\mu\text{l}$) 20 μl
2. pRC5 Vector (1 $\mu\text{g}/\mu\text{l}$) 20 μl
3. pHelper Vector (1 $\mu\text{g}/\mu\text{l}$) 20 μl
4. AAV Extraction Solution A 1.5 ml x 3
5. AAV Extraction Solution B 150 μl x 3

[Serotype 6]

AAVpro Helper Free System (AAV6) (Cat. #6651)

1. pAAV-CMV Vector (1 $\mu\text{g}/\mu\text{l}$) 20 μl
2. pRC6 Vector (1 $\mu\text{g}/\mu\text{l}$) 20 μl
3. pHelper Vector (1 $\mu\text{g}/\mu\text{l}$) 20 μl
4. AAV Extraction Solution A 1.5 ml x 3
5. AAV Extraction Solution B 150 μl x 3

AAVpro Helper Free System (AAV6-CRE Recombinase) (Cat. #6654)

1. pAAV-CRE Recombinase Vector (1 $\mu\text{g}/\mu\text{l}$) 20 μl
2. pRC6 Vector (1 $\mu\text{g}/\mu\text{l}$) 20 μl
3. pHelper Vector (1 $\mu\text{g}/\mu\text{l}$) 20 μl
4. AAV Extraction Solution A 1.5 ml x 3
5. AAV Extraction Solution B 150 μl x 3

AAVpro Helper Free System (AAV6-LacZ) (Cat. #6657)

1. pAAV-LacZ Vector (1 $\mu\text{g}/\mu\text{l}$) 20 μl
2. pRC6 Vector (1 $\mu\text{g}/\mu\text{l}$) 20 μl
3. pHelper Vector (1 $\mu\text{g}/\mu\text{l}$) 20 μl
4. AAV Extraction Solution A 1.5 ml x 3
5. AAV Extraction Solution B 150 μl x 3

High volume sets consisting of virus-production plasmids (components 2 and 3) can be purchased separately.

AAVpro Packaging Plasmid (AAV1) (Cat. #6672)

1. pRC1 Vector (1 $\mu\text{g}/\mu\text{l}$) 0.5 ml x 2
2. pHelper Vector (1 $\mu\text{g}/\mu\text{l}$) 0.5 ml x 2

AAVpro Packaging Plasmid (AAV2) (Cat. #6234)

1. pRC2-mi342 Vector (1 $\mu\text{g}/\mu\text{l}$) 0.5 ml x 2
2. pHelper Vector (1 $\mu\text{g}/\mu\text{l}$) 0.5 ml x 2

AAVpro Packaging Plasmid (AAV5) (Cat. #6664)

1. pRC5 Vector (1 $\mu\text{g}/\mu\text{l}$) 0.5 ml x 2
2. pHelper Vector (1 $\mu\text{g}/\mu\text{l}$) 0.5 ml x 2

AAVpro Packaging Plasmid (AAV6) (Cat. #6665)

1. pRC6 Vector (1 $\mu\text{g}/\mu\text{l}$) 0.5 ml x 2
2. pHelper Vector (1 $\mu\text{g}/\mu\text{l}$) 0.5 ml x 2

[Vector maps]

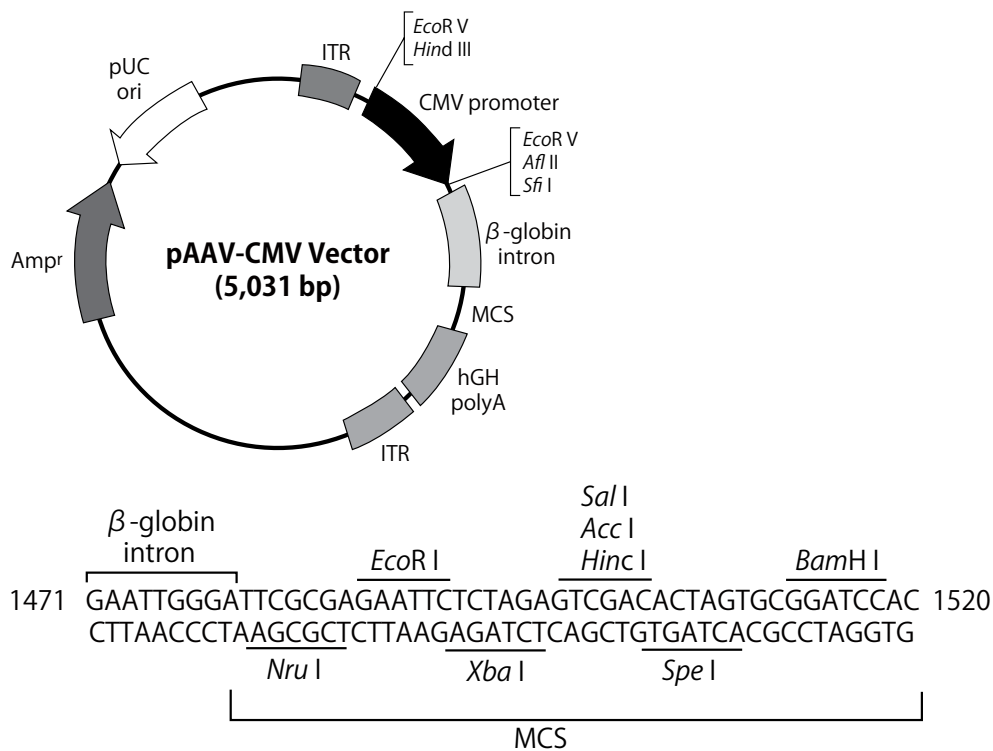

Figure 3. pAAV-CMV vector map and multiple cloning site (MCS).

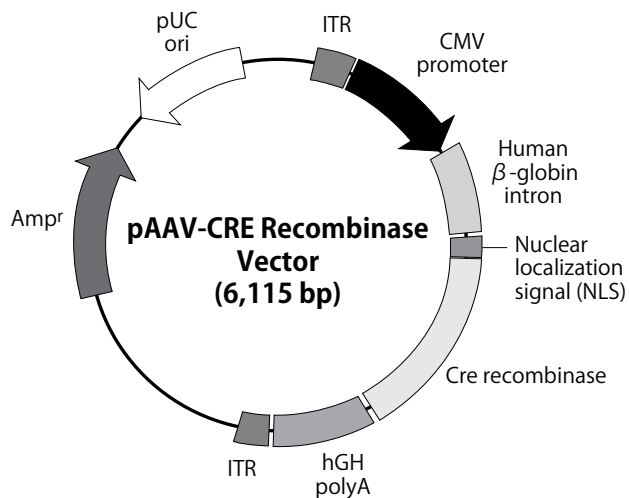

Figure 4. pAAV-CRE Recombinase vector map.

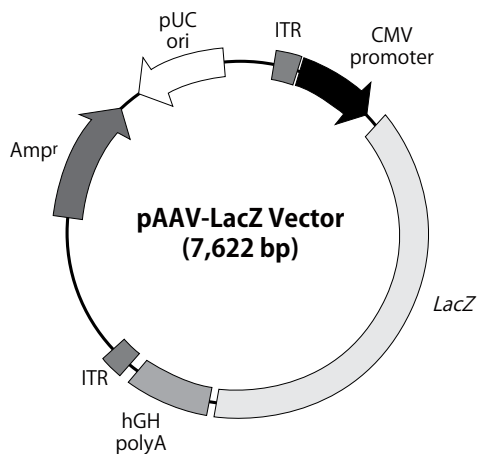

Figure 5. pAAV-LacZ vector map.

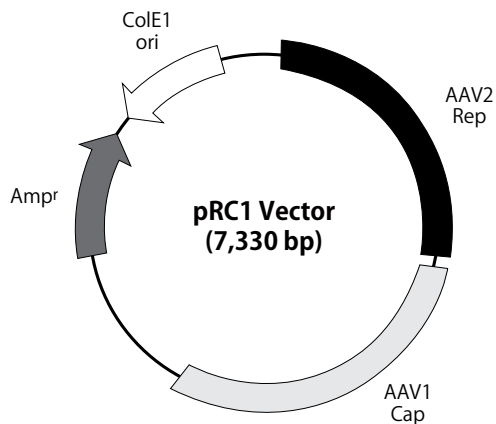

Figure 6. pRC1 vector map.

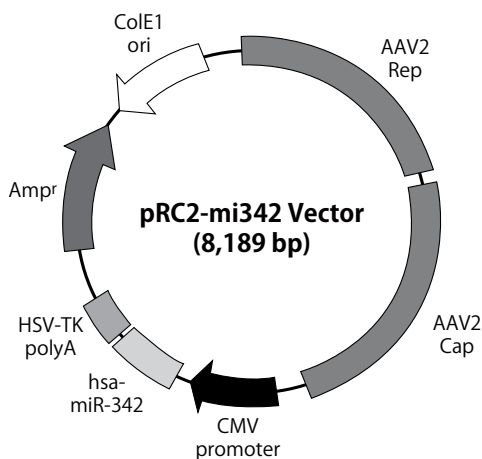

Figure 7. pRC2-mi342 vector map.

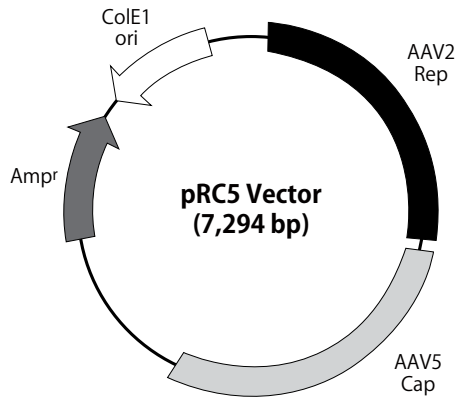

Figure 8. pRC5 vector map.

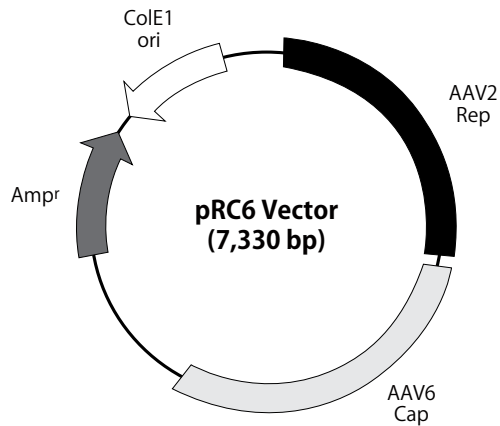

Figure 9. pRC6 vector map.

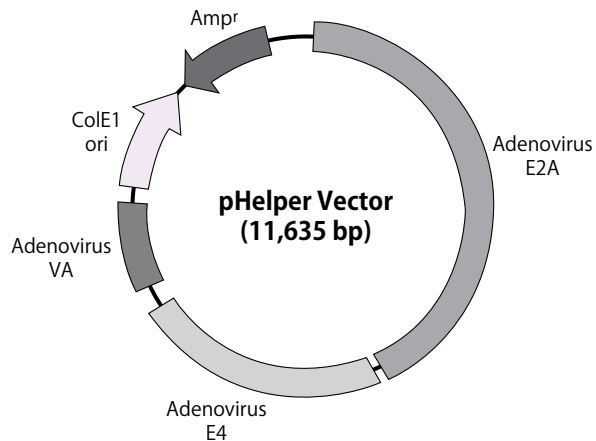

Figure 10. pHelper vector map.

III. Storage

- 20°C

Store AAV Extraction Solution A and AAV Extraction Solution B at room temperature after thawing.

Use within 2 years of receipt.

IV. Materials Required but Not Provided

IV-1. Equipment

- 100-mm diameter tissue culture-treated dishes
- General equipment for cell culture

IV-2. Reagents

- Transfection reagent
 - CalPhos™ Mammalian Transfection Kit (Cat. #631312)
 - Xfect™ Transfection Reagent (Cat. #631317)
- Dulbecco's Modified Eagle's Medium (DMEM) 4.5 g/L Glucose with L-Glutamine
- Fetal Bovine Serum (FBS)
- Trypsin-EDTA
- AAVpro 293T Cell Line (Cat. #632273)*¹
- 0.5 M EDTA (pH 8.0) [EDTA Buffer Powder, pH 8.0 (Cat. #T9191)]
- pAAV-ZsGreen1 Vector (Cat. #6231)*²

* 1 Several HEK293 and HEK293T cell lines are commercially available. Viral production is highly dependent on features of the cell line. AAVpro 293T Cell Line (Cat. #632273) and HEK293T/17 cells (ATCC, CRL-11268) are recommended for preparation of high-titer AAV.

* 2 pAAV-ZsGreen1 Vector is an AAV vector plasmid that expresses the green fluorescent protein ZsGreen. Use as a positive control to confirm the efficiency of transfection and the titer of the prepared AAV particles.

V. Overview of AAV Particle Preparation

Perform all steps from step VI-1 for AAVpro Helper Free System (AAV1/AAV2/AAV5/AAV6) (Cat. #6673, 6230, 6650, 6651) to clone a GOI. For the other systems (Cat. #6668, 6652, 6653, 6654, 6669, 6655, 6656, 6657), perform steps VI-3 through VI-7.

1. Cloning a gene of interest (GOI) into pAAV-CMV Vector
↓
2. Prepare the recombinant plasmid (pAAV-GOI vector)
↓
3. Culture AAVpro 293T cells
↓
4. Co-transfect AAVpro 293T cells with pAAV-GOI, pRC, and pHelper vectors
↓
5. Change culture medium
↓
6. Collect AAV-producing cells (2 - 3 days after transfection)
↓
7. Extract virus particles from AAV-producing cells

VI. Protocol

AAVpro Helper Free System (AAV1/AAV2/AAV5/AAV6) (Cat. #6673, 6230, 6650, 6651), need step VI-1 and VI-2. For other kits (Cat. #6668, 6652, 6653, 6654, 6669, 6655, 6656, 6657) skip to step VI-3.

VI-1. Cloning a Gene of Interest into pAAV-CMV Vector

Insert a gene of interest (GOI) into the multiple cloning site (MCS) of the pAAV-CMV vector using standard cloning methods. The In-Fusion® HD Cloning Plus kit (Cat. #638909) can also be used to easily clone PCR products derived from the GOI into any linearized vector. In addition, the CMV promoter can be replaced with another promoter using the EcoRV site in this plasmid (Figure 3).

Note 1: The GOI DNA fragment should contain an ATG start codon and a stop codon.

Note 2: The size of the GOI insert should be <2.5 kb.

VI-2. Preparation of the pAAV-GOI Vector

After confirming the presence of the correct insert in pAAV-GOI, prepare plasmid DNA using a plasmid purification kit, such as NucleoBond Xtra Midi/Maxi (Cat. #740410.10/740414.10, etc.). Adjust the plasmid DNA concentration to 1 $\mu\text{g}/\mu\text{l}$.

Note: The purity of plasmid DNA is extremely important for high transfection efficiency.

VI-3. AAVpro 293T Cell Culture

Inoculate a 100-mm cell culture dish with 2.5 - 4.0 $\times 10^6$ AAVpro 293T cells in DMEM culture medium supplemented with 10% FBS. For the CalPhos Mammalian Transfection Kit or the Xfect Transfection Reagent, 10 ml of the medium should be used. Culture overnight according to standard cell culture protocols.

VI-4. Transfection of AAVpro 293T Cells with pAAV, pRC, and pHelper

One day after plating the cells, co-transfect with a pAAV vector (either pAAV-GOI vector from VI-2, pAAV-CRE, or pAAV-LacZ), pRC vector, and pHelper vector.

For transfection, the CalPhos Mammalian Transfection Kit (Cat. #631312) or Xfect Transfection Reagent (Cat. #631317) are recommended; protocol examples for each kit are provided below.

a. CalPhos Mammalian Transfection Kit (Cat. #631312)

The following protocol is modified from the protocol recommended for CalPhos Mammalian Transfection Kit. Follow the protocol provided below to obtain a high titer of AAV solution.

1. Bring 2X HEPES-Buffered Saline to room temperature.
2. Dilute 2 M calcium solution with sterile H₂O (included in the kit) to obtain a 333 mM calcium solution (6-fold dilution), and bring to room temperature.
3. Mix the plasmid DNA and calcium solution.

pAAV Vector	1 $\mu\text{g}/\mu\text{l}$	6 μl
pRC Vector	1 $\mu\text{g}/\mu\text{l}$	6 μl
pHelper Vector	1 $\mu\text{g}/\mu\text{l}$	6 μl
Calcium Solution	333 mM	1,000 μl
Total		1,018 μl

4. Add an equal volume of 2X HEPES-Buffered Saline at room temperature. Close the lid of the tube and vigorously shake 15 times to mix.
5. Allow to stand for 3 min.

Note: Adhere to a strict 3-min incubation time, then proceed quickly to the next step. With longer incubation, large calcium phosphate-DNA complexes will form and transfection efficiency will decrease.

6. Add the mixture dropwise to the cultured AAVpro 293T cells (from Step VI-3) and culture the cells further.

Note: With the CalPhos Mammalian Transfection Kit, it is possible to check for calcium phosphate complexes using a microscope.

b. Xfect Transfection Reagent (Cat. #631317)

1. Vortex the Xfect Polymer.
2. Mix the Xfect Reaction Buffer and the plasmid DNA, and vortex vigorously for 5 sec.

pAAV Vector	1 $\mu\text{g}/\mu\text{l}$	13 μl
pRC Vector	1 $\mu\text{g}/\mu\text{l}$	13 μl
pHelper Vector	1 $\mu\text{g}/\mu\text{l}$	13 μl
Xfect Reaction Buffer		561 μl
Total		600 μl

3. Add 11.7 μl of Xfect Polymer to the plasmid mixture, and vortex vigorously for 10 sec.
4. Allow to stand for 10 min at room temperature.
5. Centrifuge the solution briefly. Add the solution dropwise to the cultured AAVpro 293T cells (Step VI-3) and culture the cells further.

VI-5. Change Culture Medium

At least 6 hours after transfection (up to 25 hours), completely replace the culture medium with fresh DMEM containing 2% FBS.

VI-6. Collection of AAV Particle-Producing Cells (2 - 3 Days after Transfection)

1. Add 1/80 volume of 0.5 M EDTA (pH 8.0) to a culture medium containing AAV-producing cells and mix well. Allow to stand at room temperature for 10 min.
2. Collect the detached cells in a sterile 15-ml centrifuge tube.
3. Centrifuge at 1,750g at 4°C for 10 min. Completely remove the supernatant and collect the cell pellet.

Note: Confirm that the supernatant has been completely removed before proceeding; viral particle isolation may be affected by residual supernatant.

VI-7. Isolation of AAV Particles from AAV-Producing Cells

The use of the AAV Extraction Solution included in the kit is strongly recommended. This method yields AAV particles with higher purity and titer than standard freeze-and-thaw or sonication methods (VIII. Reference Data).

1. Loosen the cell pellet (from step VI-6) by tapping or vortexing the tube.

Note: If the cell pellet has not been loosened sufficiently, the efficiency of extraction may decrease. Confirm that there are no clumps of cells before proceeding.

2. Add 0.5 ml of AAV Extraction Solution A.
3. Suspend the cell pellet by vortexing for 15 sec.
4. Allow to stand at room temperature for 5 min. Vortex for 15 sec again.
5. Centrifuge at 2,000 - 14,000g at 4°C for 10 min to remove cell debris.

Note: If the titer of the recovered AAV vector is low, the efficiency may be increased by repeating steps 3 - 5.

6. Collect the supernatant in a new sterile centrifuge tube and add 50 μ l of AAV Extraction Solution B and mix by pipetting to prepare AAV solution.

Note 1: The AAV solution can be stored at -80°C. Thaw quickly in a 37°C water bath before use.

Note 2: The supernatant may change to a pink color after AAV Extraction Solution B is added.

VII. Measurement of Virus Titer

Virus titer can be measured by real-time PCR (vector genome assay) or by infection assay (biological titer measurement). Real-time PCR analysis of vector genomes provides rapid quantification, whereas determining titer by infection into cells is generally more accurate to determine infectious virus titer. There are other titration methods for AAV vectors that involve assay of viral capsid proteins, but these methods may detect nonfunctional (empty) particles.

Vector Genome Assay

The AAVpro Titration Kit (for Real Time PCR) Ver.2 (Cat. #6233) can be used to measure virus titer by real-time PCR analysis using the viral ITR domain as a target.

Biological Titer Measurement

The titer is determined by measuring the expression of the gene of interest. The protocol below is a titration method using a AAV2 vector expressing the fluorescent protein ZsGreen (pAAV-ZsGreen1 Vector (Cat. #6231)).

1. Prepare target cells at a density of $2 - 4 \times 10^4$ cells/ml in DMEM with 10% FBS.
2. Inoculate several wells of a 24-well plate with 0.5 ml of the cell suspension and culture overnight.
3. Prepare serial dilutions of the prepared AAV2 particle solution using DMEM with 10% FBS and then infect the cell with the diluted virus solution. The dilution ratio depends on the virus titer, but serial dilutions in the 1,000 - 100,000-fold range are recommended.
4. Three days after infection, detach the cells using Trypsin/EDTA, and analyze ZsGreen expression by flow cytometry.

VIII. Reference Data

VIII-1. Increase in AAV2 Titer by the pRC2-mi342 Vector

The pRC2-mi342 vector included in corresponding kits (Cat. #6230, 6652, 6655) can be used to produce high titer recombinant AAV2 particles.

[Methods]

Virus producing Cells: HEK293

Transfection: Calcium phosphate method

Plasmids:

- pAAV-CMV-AcGFP1 Vector
- pRC2-mi342 Vector or pRC2 Vector*
- pHelper Vector

Culture: T25 Flask

* pRC2 Vector: Vector lacking the hsa-miR-342 expression cassette

AAV2 particles were extracted and the titer was evaluated by real-time PCR.

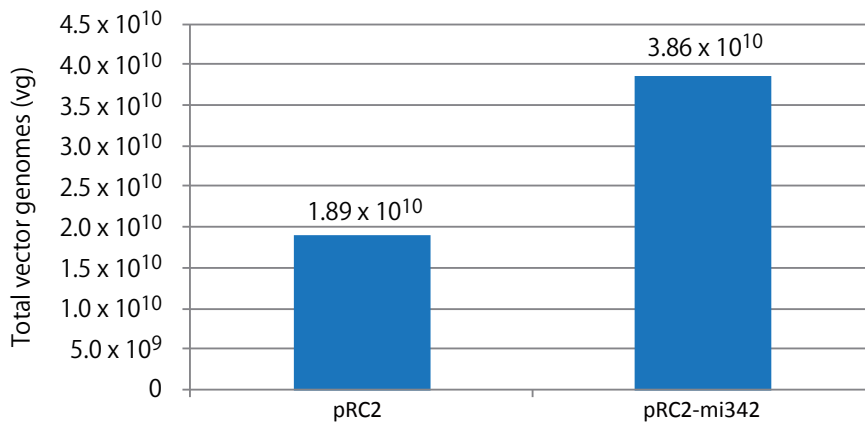

Figure 11. Effect of miRNA-342 on AAV2 production.

[Results]

The pRC2-mi342 vector resulted in a two-fold increase in titer (vector genomes) as compared to pRC2.

VIII-2. Efficiency of AAV Particle Extraction Using AAV Extraction Solution

The AAV Extraction Solutions A and B in this system can be used to easily and efficiently extract AAV particles from AAV-producing cells.

A. Comparison with Freeze-Thaw Method; Virus Yield

HEK293 cells were transfected with the pAAV-ZsGreen1 vector (Cat. #6231) and corresponding plasmids for each AAV serotype. AAV particles expressing ZsGreen1 were extracted from the cells using either AAVpro Extraction Solution or the freeze-and-thaw method. The titer of the viral extract was determined using the vector genome assay (Figure 12A) and biological titer measurement with HT1080 cells (Figure 12B). The infectious AAV virus can be obtained easily and efficiently using AAVpro Extraction Solution.

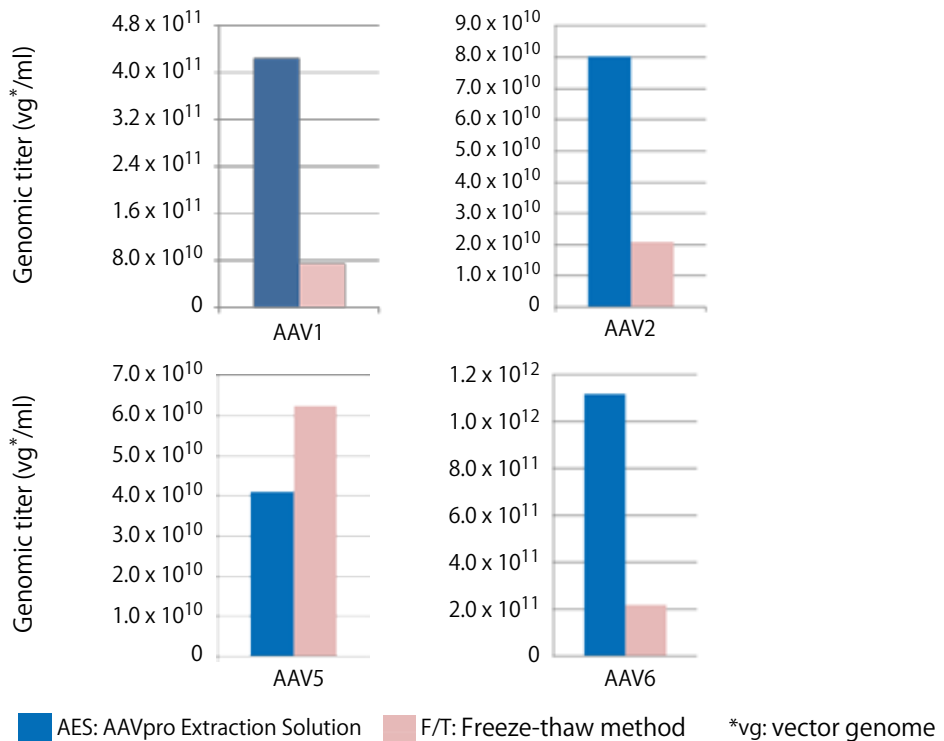

Figure 12A. AAV extraction efficiency using AAVpro Extraction Solution (vector genome assay).

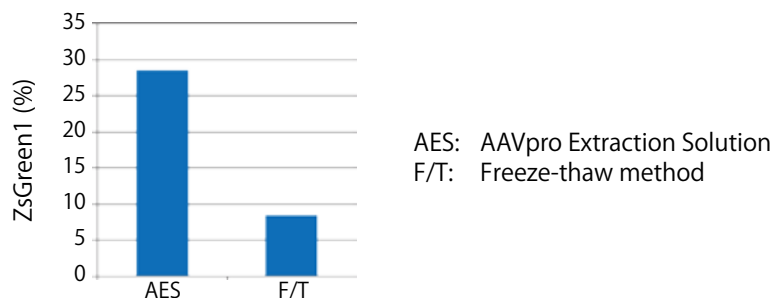
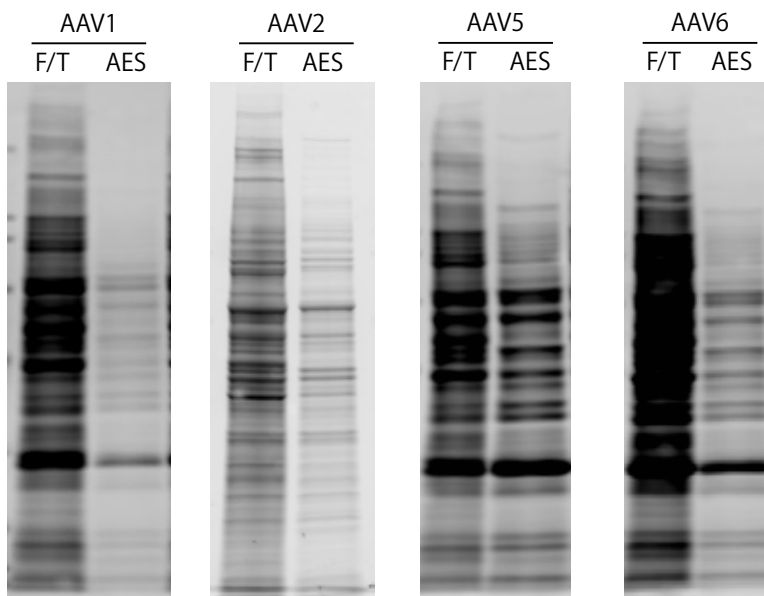

Figure 12B. AAV2 extraction efficiency using AAVpro Extraction Solution (biological titer).

B. Comparison with Freeze-Thaw Method; Purity

AAV particles were obtained from HEK 293 producer cells using AAVpro Extraction Solution or the freeze-thaw method. The amount of viral genomic DNA in each AAV extract was quantified by real-time PCR. Then, the equivalent of 1×10^9 vg of each AAV extract was analyzed by SDS-PAGE to evaluate the amount of protein impurity (Figure 13). In addition, residual cellular dsDNA content in each AAV2 extract was assayed using the intercalation method (Figure 14). The results indicate that the use of the AAVpro Extraction Solution clearly reduced the amount of protein impurities and dsDNA in comparison with the freeze-thaw method.



AES: AAVpro Extraction Solution F/T: Freeze-and-Thaw Method (1×10^9 vg/lane)

Figure 13. SDS-PAGE of AAV extracts. The purity of AAV prepared using the AAV Extraction solution (AES) was far greater than the freeze-thaw method (F/T).

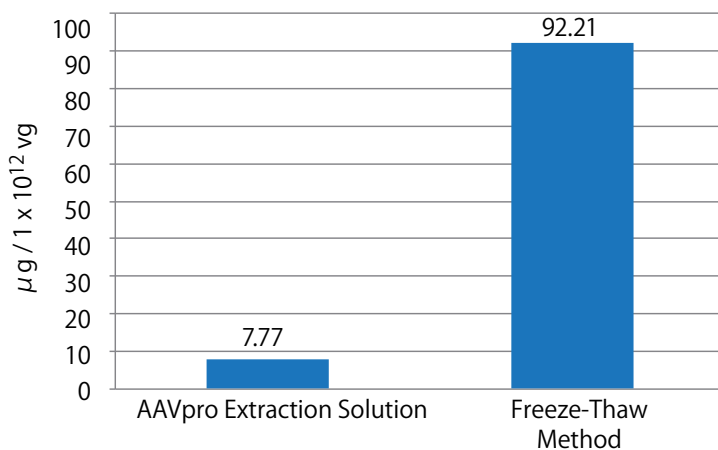

Figure 14. dsDNA in AAV2 extracts. Residual dsDNA was less when AAV2 was prepared using the AAVpro Extraction Solution (AES) as compared to the freeze-thaw method (F/T).

VIII-3. Infection with AAV2-CRE particles

AAV2-CRE viral particles were prepared using the AAVpro Helper Free System (AAV2-CRE Recombinase) (Cat. #6652) and purified using the AAVpro Purification Kit (AAV2) (Cat. #6232). Particles were used to infect HEK 293 cells that are engineered to fluoresce (ZsGreen1) when recombination occurs with Cre recombinase. The proportion of fluorescent cells correlated positively with the amount of AAV2-Cre particles used for infection.

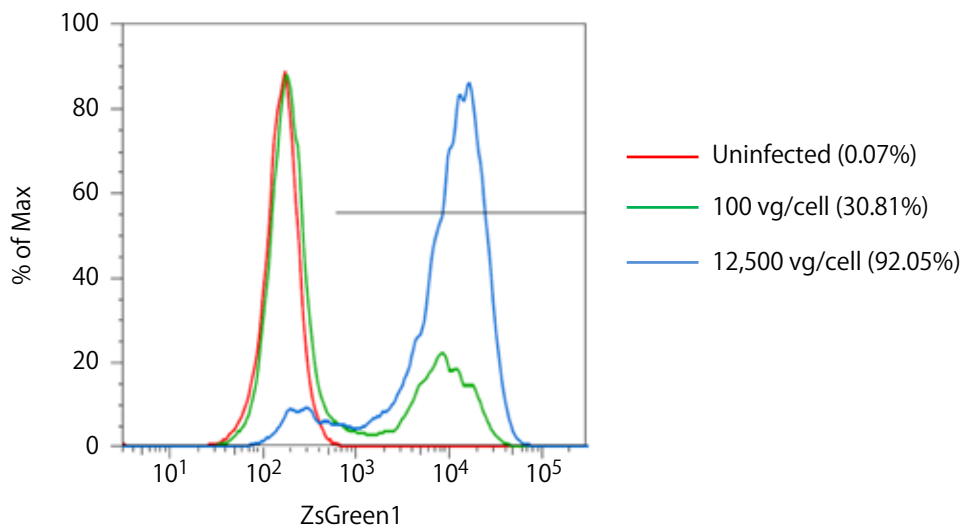

Figure 15. FACS analysis of HEK 293 cells infected with AAV2-CRE particles.

VIII-4. Infection with AAV2-LacZ Particles

AAV2-LacZ viral particles were prepared using the AAVpro Helper Free System (AAV2-LacZ) (Cat. #6655) and purified using the AAVpro Purification Kit (AAV2) (Cat. #6232). Particles were used to infect HT1080 cells. Staining was performed using the Beta-Galactosidase Staining Kit (Cat. #631780).

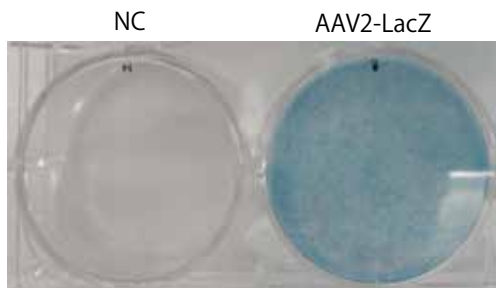

Figure 16. X-gal staining of HT1080 cells infected with AAV2-LacZ particles.

IX. References

- 1) Miyake, *et al. J Nippon Med Sch.* (2012) **79**(6): 394-402.
- 2) Van Vliet, *et al. Methods Mol Biol.* (2008) **437**: 51-91.
- 3) Wu, *et al. Mol Ther.* (2006) **14**(3): 316-27.
- 4) Zincarelli, *et al. Mol Ther.* (2008) **16**(6): 1073-80.
- 5) Ellis, *et al. Virol J.* (2013) **10**: 74.

X. Related Products

pAAV-ZsGreen1 Vector (Cat. #6231)
AAVpro® Purification Kit (All Serotypes) (Cat. #6666)
AAVpro® Purification Kit (AAV2) (Cat. #6232)
AAVpro® Titration Kit (for Real Time PCR) Ver.2 (Cat. #6233)
AAVpro® Extraction Solution (Cat. #6235)
AAVpro® Packaging Plasmid (AAV1) (Cat. #6672)
AAVpro® Packaging Plasmid (AAV2) (Cat. #6234)
AAVpro® Packaging Plasmid (AAV5) (Cat. #6664)
AAVpro® Packaging Plasmid (AAV6) (Cat. #6665)
CalPhos™ Mammalian Transfection Kit (Cat. #631312)
Xfect™ Transfection Reagent (Cat. #631317/631318)
AAVpro® 293T Cell Line (Cat. #632273)
Beta-Galactosidase Staining Kit (Cat. #631780)

AAVpro is a registered trademark of TAKARA BIO INC.

In-Fusion is a registered trademark of Takara Bio USA, Inc.

CalPhos and Xfect are trademarks of Takara Bio USA, Inc.

NOTE: This product is for research use only. It is not intended for use in therapeutic or diagnostic procedures for humans or animals. Also, do not use this product as food, cosmetic, or household item, etc.

Takara products may not be resold or transferred, modified for resale or transfer, or used to manufacture commercial products without written approval from TAKARA BIO INC.

If you require licenses for other use, please contact us by phone at +81 77 565 6973 or from our website at www.takara-bio.com.

Your use of this product is also subject to compliance with any applicable licensing requirements described on the product web page. It is your responsibility to review, understand and adhere to any restrictions imposed by such statements.

All trademarks are the property of their respective owners. Certain trademarks may not be registered in all jurisdictions.
